

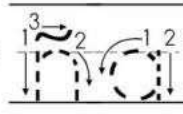

# La letra: ñ



ñ = ña → 

ñ = ñe → 

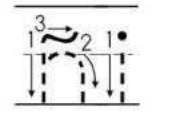
ñ = ñi → 

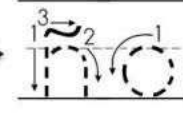
ñ = ño → 

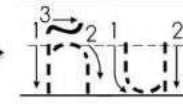
ñ = ñu → 

ña ña ña

ñe ñe ñe

ñi ñi ñi

ño ño ño

ñu ñu ñu

# La letra: p

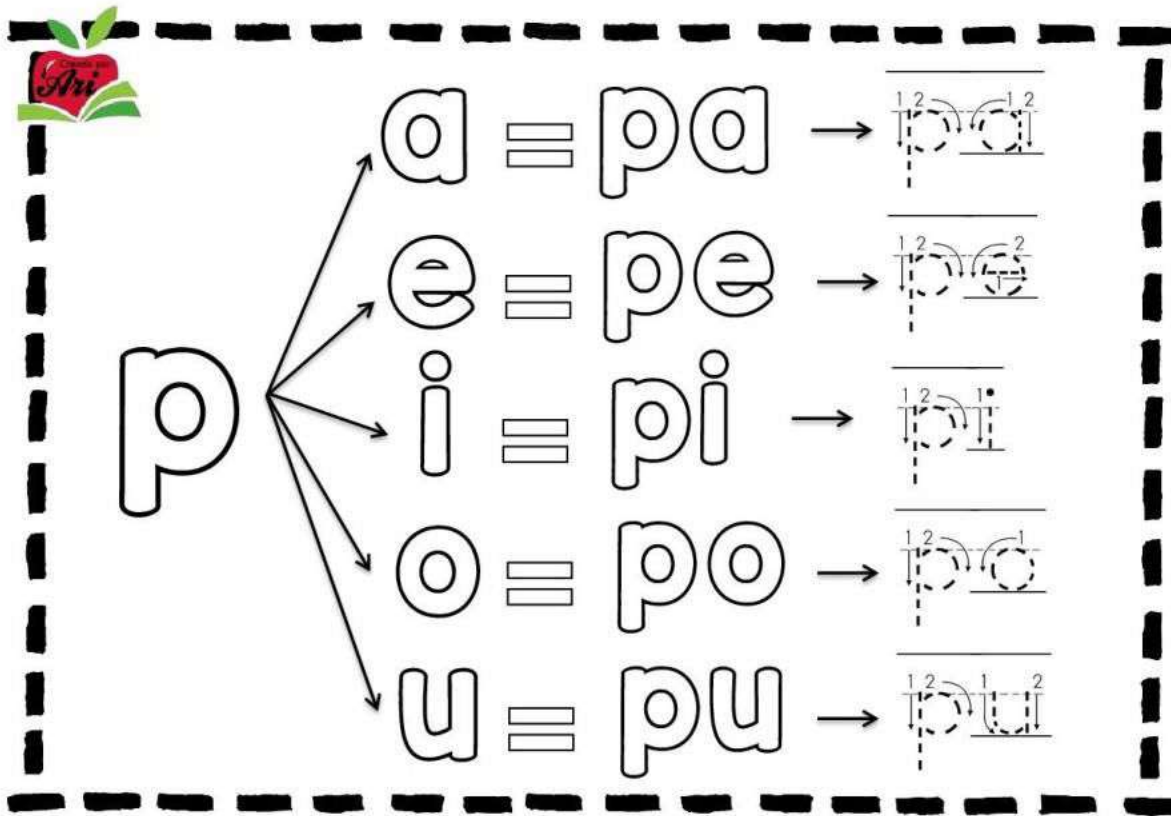

**p**

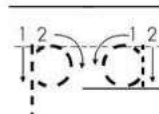
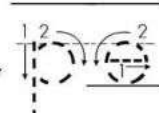
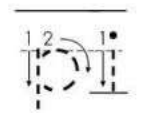
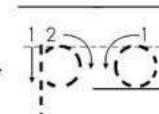
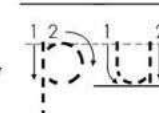
- a = pa → 
- e = pe → 
- i = pi → 
- o = po → 
- u = pu → 

pa pa pa

pe pe pe

pi pi pi

po po po

pu pu pu

La letra **Q** es diferente:



**q** + **u** = **e** = **que**  
**q** + **u** = **i** = **qui**

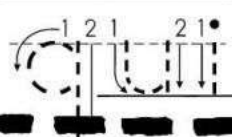
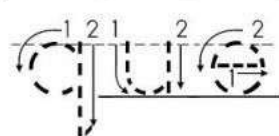

que que que que

qui qui qui qui qui

# La letra: r



r

a = ra → 

e = re → 

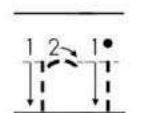
i = ri → 

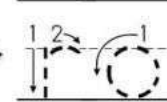
o = ro → 

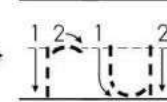
u = ru → 

ra ra ra

re re re



ri ri ri

ro ro ro

ru ru ru

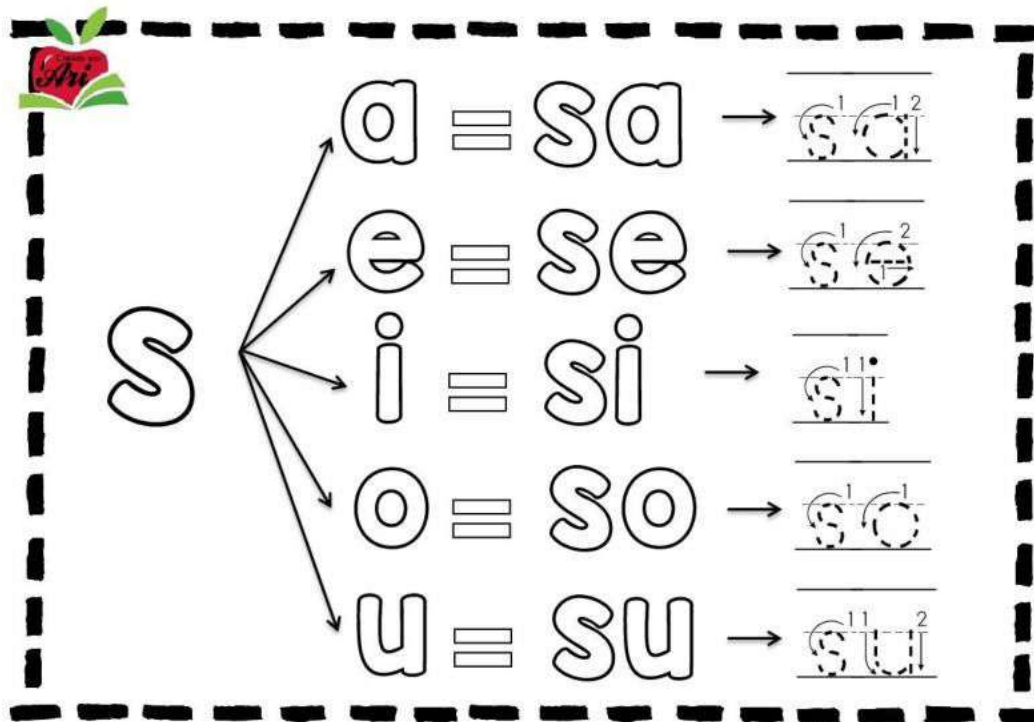
# La letra: S

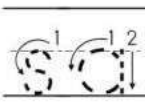
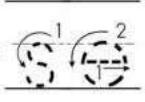

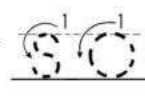
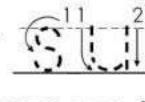
**S** → a = sa →   
e = se →   
i = si →   
o = so →   
u = su → 

sa sa sa

se se se

si si si

so so so

su su su

# La letra: t

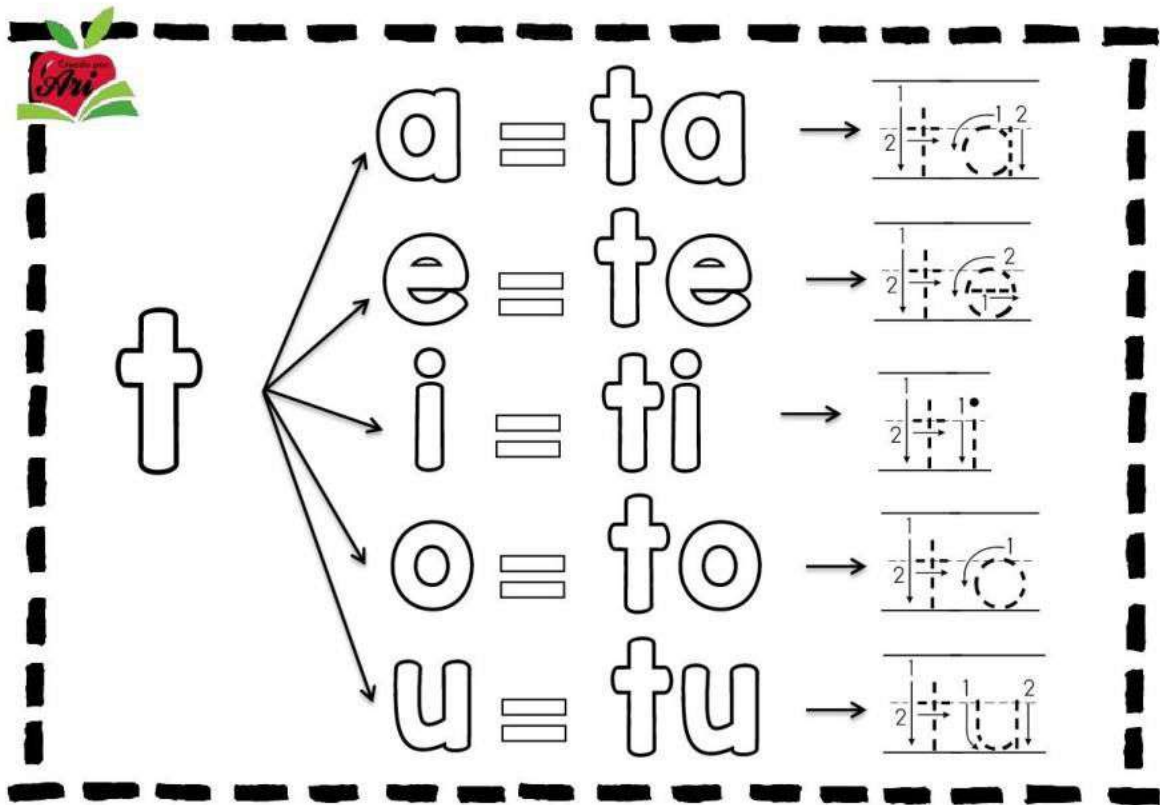

t

a = ta →

e = te →

i = ti →

o = to →

u = tu →

ta ta ta

te te te

ti ti ti

to to to

tu tu tu

# La letra: V

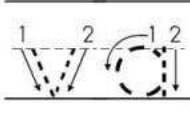

**v** → **a = va** → 

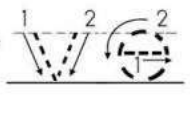
**v** → **e = ve** → 

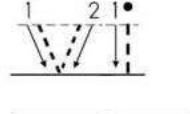
**v** → **i = vi** → 

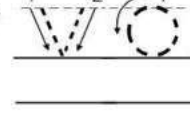
**v** → **o = vo** → 

**v** → **u = vu** → 

va va va

ve ve ve

vi vi vi

vo vo vo

vu vu vu

# La letra: W



W

a = wa → 

e = we → 

i = wi → 

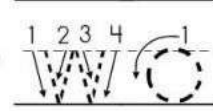
o = wo → 

u = wu → 

wa wa wa

we we we

wi wi wi

wo wo wo

wu wu wu



# La letra: X

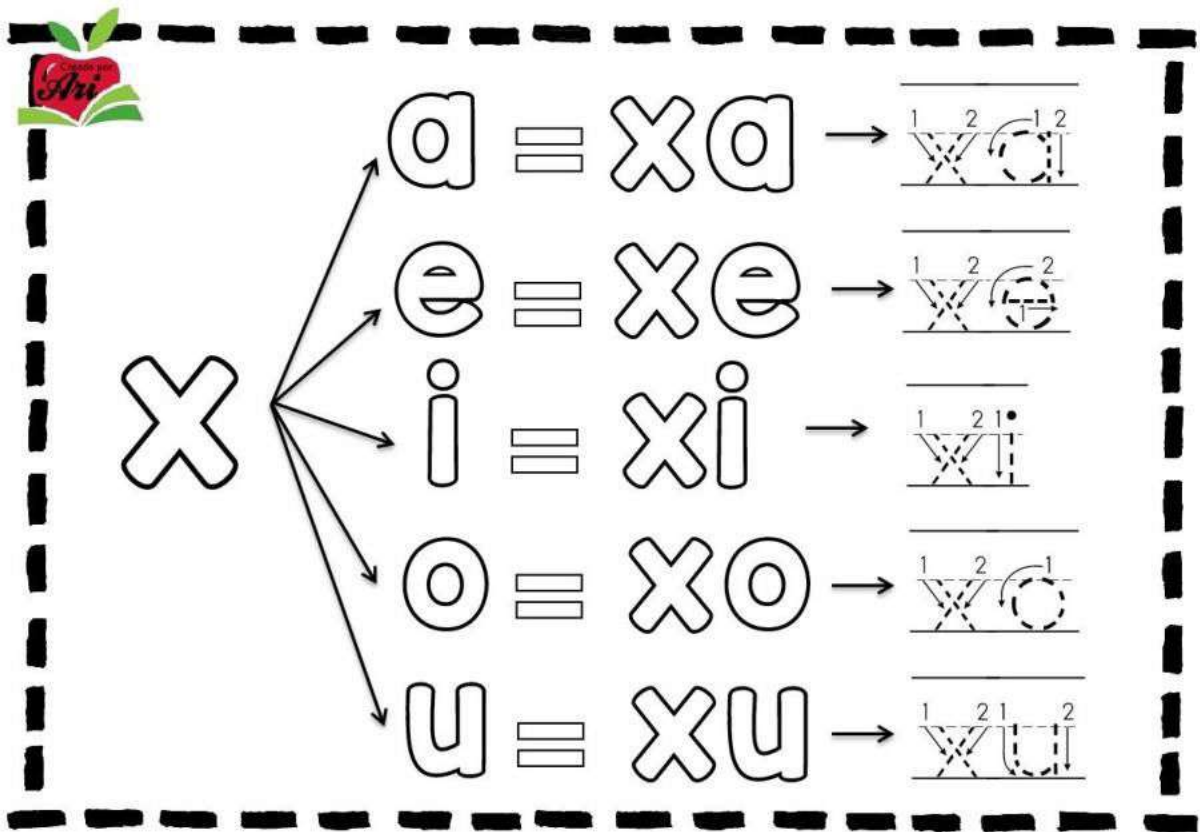

**X** → a = xa → e = xe → i = xi → o = xo → u = xu

xa xa xa

xe xe xe

xi xi xi

xo xo xo

xu xu xu

# La letra: y

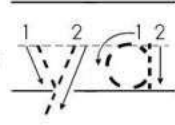

y

a = ya → 

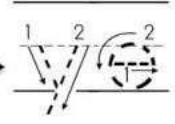
e = ye → 

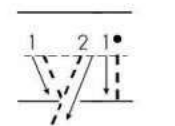
i = yi → 

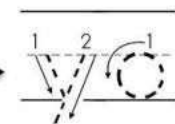
o = yo → 

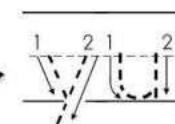
u = yu → 

ya ya ya

ye ye ye

yi yi yi

yo yo yo

yu yu yu

# La letra: Z

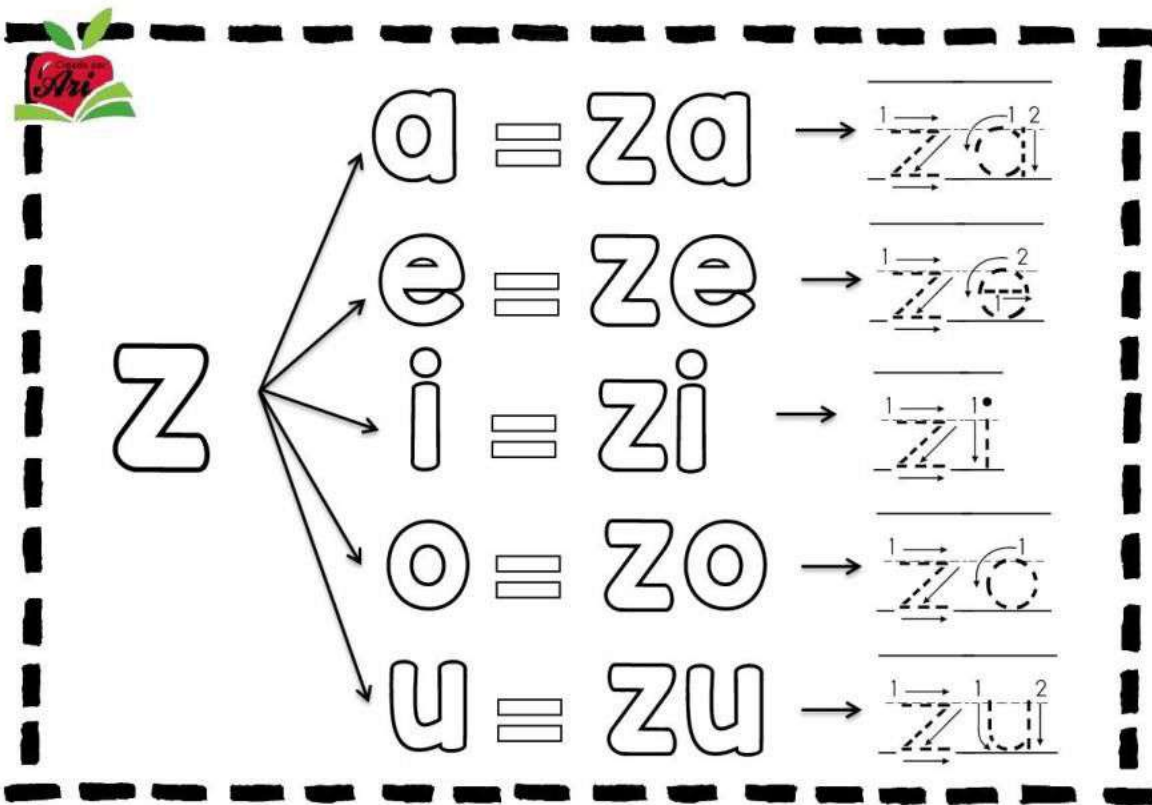

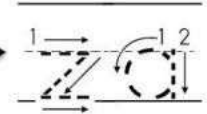
z → a = za → 

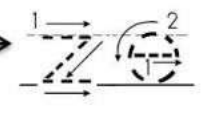
z → e = ze → 

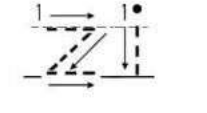
z → i = zi → 

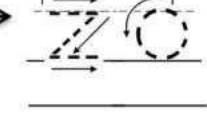
z → o = zo → 

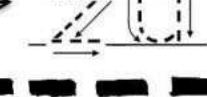
z → u = zu → 

za za za

ze ze ze

zi zi zi

zo zo zo

zu zu zu